

MICROCHANNEL REACTOR STACKED BY BRAZING METHOD

S.P. Yu, W.Y. Lee, C.S. Kim, S.J Lee* and K.S. Song*

Fuel Cell Research Center, KIER, South Korea, spyu@kier.re.kr

*Catalyst Application Research Center, KIER, South Korea, kssong@kier.re.kr

ABSTRACT

Each stack of microstructured stainless steel and aluminum plates was coated and brazed in vacuum. As a supporter of catalyst, the coating layer was formed by sol-gel method and anodizing respectively. Though the number of brazed plates extended to a hundred, the thickness of coating layer on the respectively coated plate was relatively uniform and the leakage of assembly was effectively minimized. The critical variables for brazing were both thickness and shape of filler metal. Consequently, brazing method had good resolution for 200 μ m three dimensional multi layer structures. Through these results, coating to support catalysts in highly stacked layers by brazing can be applied to micro catalytic heat exchanger where the reaction and heat transfer occur simultaneously.

Keywords: microchannel, catalytic reaction, brazing, heat exchanger

1 INTRODUCTION

As the micro systems get more wireless and higher performed, their energy sources need to get denser. Recently, catalytic reaction which could be used to produces hydrogen is noticed as one of the issues of micro power systems. If we use chemical reaction energy directly in micro power systems, the density of that is as hundreds times as that of the latest lithium-ion battery system.

Catalytic combustion has three characteristics; the first is that the temperature of it can be controlled below 500°C or much lower, the second is that it has no limit of room for combustion such as quenching distance, and the last is that it can produce various desired chemicals in partial oxidation. Through these, catalytic reaction has been accepted to be very suitable to following micro systems ; the pre-processor of micro fuel cell system, micro chemical plant, micro propulsion system.

The microchannel reactors and heat exchangers have been made of mechanically microstructured metal foils of stainless steel, hastelloy, aluminum, copper, palladium, silver, and others [1]. A reactor is assembled from individual metal plates with micro channels having cross sections in the range of 50–300 μ m. These metal plates are assembled by bolting, gaskets such as graphite or diffusion bonding. Brazing is employed to connect the parent metals : a filler metal, such as Nickel based alloys, is placed, for example in a foil form, between the parts to be brazed and

heated upon its melting point. It allows to create tight chemical bonds between parts. Contrary to welding, parent parts are not melted. Below 450°C, brazing is called soldering. After brazing, there are little deformation and residual stresses in the parent metal which is not melted. Moreover, using metal as a bond, joints are tight and heat conductivity between the parent metals is higher than using graphite or polymer as a bond. On the other hand, for a wider application with chemical reactions it is necessary to provide oxide coatings as carriers for metal catalysts to increase the overall inner surface area of the microchannels [1]. Catalytic coatings are important in microstructured reactors, since they can minimize mass transfer resistance and pressure drop, and improve heat conduction for catalytic reactions. Several techniques have been utilized for coating microchannels with porous oxides: anodic oxidation which has been used to provide a porous layer on aluminum [2,3]; chemical vapor deposition [4]; deposition of nanoparticles [5]; and sol-gel process [1]. In these coating processes, sol-gel is relatively simple to use and compatible to various kind of metals, but the uniformity and adhesion of coating layers are weak. Anodizing leads to formation of unbranched, regular and nearly concentric pores, which is advantageous for catalytic reactions [6]. Moreover, the strength of adhesion of the anodic oxide layer to the support is strong. But it can only be applied to aluminum and not stainless steel.

In applying catalytic reaction to micro system, fabrication and coating to support catalysts are correlated with each other because the manufacturing process is dependent mutually. This study introduces vacuum brazing technique for assembly of microchanneled stainless steel and aluminum plates. It is also attempted to braze microchanneled stainless steel plates coated with alumina. Two cases were studied : alumina coatings were applied both before and after brazing. In the case of aluminum plates, anodizing is performed instead of the sol-gel method.

2 EXPERIMENTAL

The diagram of manufacturing process is shown in Figure 1. In the design of the micro heat exchanger, uniformity in fluid velocity distribution was considered, referring to Commenge et al. [7]. Main design factors were curvature ratio at the end of microchannels, ratio of depth to width in microchannels, a number of microchannels, length of microchannels and area ratio of wall to microchannels. Top and bottom covers were prepared by machining in 4 ×

4 cm² of size. The name of stainless steel plate was SUS304 and that of aluminum plate was AL1050.

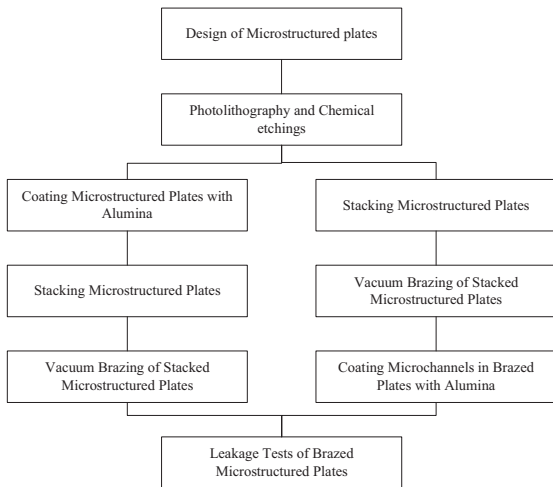

Figure 1. Diagram of manufacturing process for catalytic micro heat exchanger.

Microchannels were created by photolithography and chemical etchings and the details for microchanneled plates are summarized in Table 1.

Material	Stainless Steel	Aluminum
Plate geometry	40 × 40 × 0.3 mm ³	40 × 40 × 0.3 mm ³
Microchannel cross-sectional area	20 × 20mm ²	20 × 20 mm ²
Microchannel cross-sectional area	300 μm	500 μm
Microchannel cross-sectional area	200 μm	200 μm
Number of channels on one foil	34	21

Table 1. Details of microchanneled plates

For assembly of the microchanneled plates, they were stacked up as shown in Figure 2 and pure nickel foils were inserted between the microchanneled plates for vacuum brazing. The shapes of filler metal sheets are shown in Figure 3. The thickness of nickel foils was 38μm, and the width of them were ranged from 2.5mm to plate edge. At each case, the room between layers of brazed stack was different. If there are impurities on the surface of the parent metal, adhesion force of brazing can be diminished. Therefore, the surface of the parent metal was degreased by alcohol before brazing. Vacuum brazing lasted for 15minutes at 1000 °C, below 10⁻⁵ torr. The assembled microchanneled plates were tested for leakage with a leak detector (ASM 142, Alcatel). Leakage tests were performed in ambient air firstly, and then in latex globe filled with helium gas.

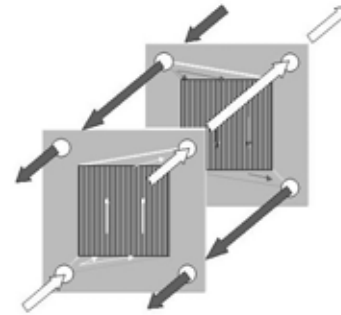

Figure 2. Schematics of stacking microstructured plates.

For incorporation of catalysts, a microchanneled stainless steel plate was coated with aluminum oxide films by dip-coating with alumina sol, followed by drying in air at 120 °C overnight. Alumina coated stainless steel plates were brazed under vacuum with nickel filler metal. On the other hand, microchannels in assembled stainless steel plates were coated by flowing alumina sol followed by blowing excess alumina sol with compressed air and then drying in air at 120 °C overnight.



Figure 3. The shapes of filler metal sheets and cross section at each brazing case. (a) nickel foil, thickness: 38μm, width 3.5mm (b) Cross section of brazed stack (×100)

The microchanneled aluminum foils were rinsed with ethanol and deionized water and then dried with compressed air. The electrode was immersed in 165 g/l H₂SO₄ solution which was circulated with a pump to remove heat generated during anodizing. For constant current operation, the current desired was set on a power supply. Anodizing time was varied from 10 to 30 min. The anodized aluminum foils were washed with deionized water followed by drying in air at room temperature. In aluminum stack, copper was used as filler metal and vacuum brazing lasted for 15 minutes at 400 °C, below 10⁻⁵ torr.

3 RESULT AND DISCUSSION

Microchanneled stainless steel plate and assembly of microchanneled stainless steel plates are shown in Figure 4. The assembly of microchanneled stainless steel plates was tested for leakage in air and helium environments. Leaking rates are 3.3 × 10⁻¹⁰ torr l/sec and 1.5 × 10⁻⁶ torr l/sec in air and helium environments, respectively. Considering that

Swagelok fittings are utilized below 1×10^{-6} torr l/sec, our results might be caused by leaking from the fittings rather than from gaps between brazed plates.

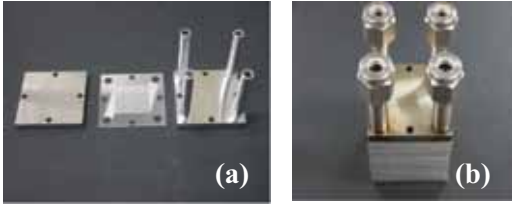

Figure 4. Photographs of (a) a microchanneled stainless steel plate and top and bottom covers and (b) assembly of microchanneled stainless steel plates by vacuum brazing.

In order to examine brazed plates, the assembly of microchanneled stainless steel plates was cut by wire-cutting method. Figure 5 shows both the cross sections and the brazed part of the assembly of microchanneled stainless steel plates. The microchannel shape is not rectangular but hemi-circular due to using photo-etchings. It is known that the amount of filler metals is important at brazing technology, as excess filler metals could block microchannels and lack filler metal could cause leaking. In our case, appropriate amount of filler metals was found by varying thickness and width of filler metals. Thus, no gaps are observed between brazed stainless steel plates (see Figure 5(b)). In the microchanneled stainless steel plates brazed and then coated with alumina, SEM picture shows that $3 \mu\text{m}$ of alumina film is successfully incorporated onto the microchannels (see Figure 6).

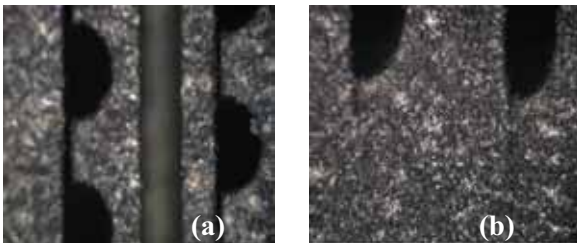

Figure 5. Photographs of (a) cross section and (b) brazed part of assembly of microchanneled stainless steel plates.

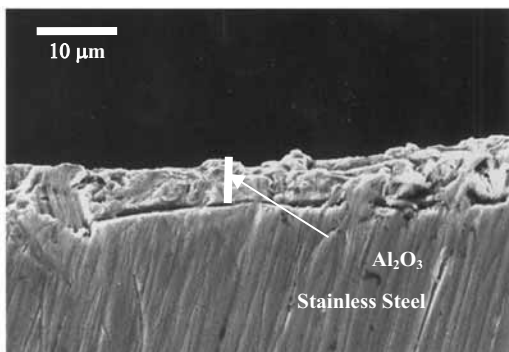

Figure 6. SEM picture of microchanneled stainless steel plates brazed and then coated with alumina.

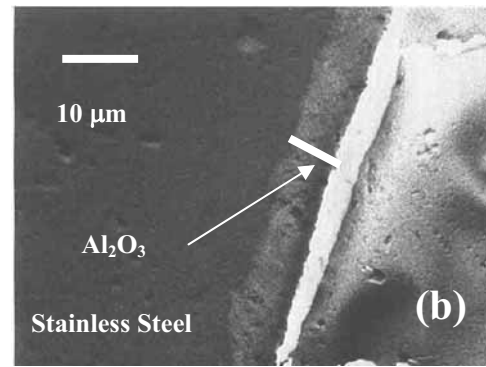
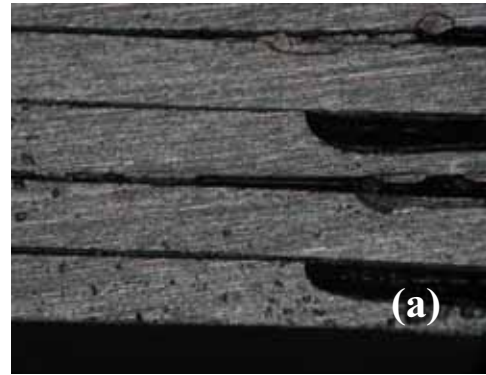

Figure 7. Photographs of (a) brazed part and (b) cross section of microchanneled stainless steel plates coated with alumina and then brazed.

In microstructured stainless steel plates coated with alumina and then brazed, a photograph of cross section of microchannels reveals that thickness of coated alumina film is about $2.8 \mu\text{m}$ (see Figure 7(b)). However, it is observed that large gaps between brazed plates are present, as vacuum brazing does not work with ceramics such as alumina (see Figure 7(a)).

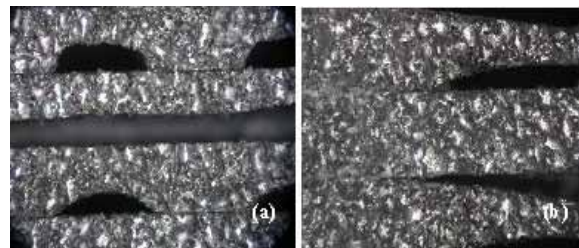

Figure 8. Photographs of (a) cross section and (b) brazed part of assembly of microchanneled aluminum plates by vacuum brazing.

As done in brazing stainless steel plates, proper amount of filler metals for aluminum brazing was investigated by varying thickness and width of filler metals. Figure 8 exhibits that cross section of brazed assembly of microstructured aluminum plates. The shape of

microchannels on aluminum plates is irregular, since it is difficult to control etching rate with soft metals such as aluminum (see Figure 8 (a)). However, Figure 8(b) represents that microstructured aluminum plates can be successfully brazed as shown in brazing stainless steel plates.

4 CONCLUSION

Microstructured stainless steel plates were successfully brazed with nickel filler under vacuum. However, vacuum brazing did not work properly with the microstructured stainless steel plates coated with alumina. Thus, it was necessary to clean the surface for brazing or to coat only microchannels with alumina. It was also demonstrated that microchannels could be coated with alumina after brazing stainless steel plates. Microstructured aluminum plates were also brazed successfully. But in anodized aluminum plates brazing does not work effectively. Coating to support catalysts in highly stacked layers by brazing can be applied to micro catalytic heat exchanger where the reaction and heat transfer occur simultaneously.

REFERENCES

- [1] K. Haas-Santo, O. Gorke, P. Pfeifer, K. Schubert, *Chimia*, 56 (11), pp.605-610, 2002.
- [2] G. Wießmeier, K. Schubert, D. Hönicke, in *Proceedings of the 1st International Conference on Microreaction Technology*, pp. 20–26, Springer, Berlin, 1997.
- [3] R. Wunsch, M. Fichtner, K. Schubert, in *Proceedings of the 4th International Conference on Microreaction Technology*, pp. 481–487, Atlanta, 6–10 March 2000.
- [4] M. Janicke, H. Kestenbaum, U. Hagendorf, F. Schüth, M. Fichtner, K. Schubert, *J. Catal.* 192, pp.282–293, 2000.
- [5] P. Pfeifer, M. Fichtner, K. Schubert, M. Liauw, G. Emig, in: *Proceedings of the 3rd International Conference on Microreaction Technology*, pp. 372–382, Frankfurt, 19–21 April 1999.
- [6] G. Wießmeier, D. Hönicke, *J. Micromech. Microeng.* 6, pp.285. 1996.
- [7] J. M. Commenge, L. Falk, J. P. Corriou and M. Matlosz, *AIChE Journal*, vol.48, pp.345-358, 2002.